

INVERTERS ADAC

AD M/T 1.0 AC - AD M/T 1.5 AC - AD M/T 2.2 AC
AD T/T 3.0 AC - AD T/T 4.0 AC - AD T/T 5.5 AC
AD T/T 7.5 AC - AD T/T 11.0 AC - AD T/T 15.0 AC





Description

The ADAC is the leading edge of the Wacs inverters. The 3 models of this family are ideal for professional and very severe applications. ADAC can drive pumps of up to 15 kW. These units combine the simplicity of the ADAC series with the robust design and power of an inverter drive. They can be installed in a control panel and must be supplied with external pressure and flow sensors. The use of a flow sensor, moreover, allows a better pressure regulation. The ADAC can easily be set up in booster sets, thanks to a standard wire cable connection. Comfort, energy saving, protections and simplicity are the keywords of this professional series.

Benefits

Why the Dab inverter?

The ADAC units are air cooled. These extremely robust panel-mounting inverters feature a metal body and are suitable for heavy-duty applications. Operation of these inverters calls for the presence of a pressure sensor and, optionally, a flow sensor. ADAC combines practicality with easy installation and management. ADAC ensure the utmost practicality and increase the average working life of the system, permitting also significant savings in power consumption.

Advantages

- Easily installed in existing systems
- Constant pressure
- Power consumption reduced by up to 60%
- Built-in protections
- Operates with all pumps
- Robust
- Facility to create sets with interchange of up to 8 pumps



Characteristics

AD M/T 1.0 AC – AD M/T 1.5 AC- AD M/T 2.2 AC

- Self-ventilated panel-mounting inverters for hydraulic pumps.
- For three-phase pumps up to 3 HP - 2.2 kW
- OLED graphic display
- Input power supply 1 x 230V 50-60Hz
- Pump voltage 3 x 230V
- Electric pump nominal frequency 50-200 Hz
- Control range in accordance with the sensor utilised, with standard range of 1-24bar
- Protections against voltage surges
- Adjustable overload protection
- Built-in flow sensor (Optional)
- Extended connectivity
- Protection rating: IP20
- Dry run protection
- Short circuit between output phases
- Overtemperature protection
- Anti-seize and anti-frost function
- Facility to create booster sets with up to 8 inverters

AD T/T 3.0 AC – AD T/T 4.0 AC - AD T/T 5.5 AC

- Self-ventilated panel-mounting inverters for hydraulic pumps.
- For three-phase pumps up to 7.5 HP - 5.5 kW
- OLED graphic display
- Input power supply 3 x 400V 50-60Hz
- Pump voltage 3 x 400V
- Electric pump nominal frequency 50-200 Hz
- Control range in accordance with the sensor utilised, with standard range of 1-24bar
- Protections against voltage surges
- Adjustable overload protection
- Built-in flow sensor
- Extended connectivity
- Protection rating: IP20
- Dry run protection
- Short circuit between output phases
- Overtemperature protection
- Anti-seize and anti-frost function
- Facility to create booster sets with up to 8 inverters

AD T/T 7.5 AC – AD T/T 11.0 AC- AD T/T 15.0 AC

- Self-ventilated panel-mounting inverters for hydraulic pumps.
- For three-phase pumps up to 20HP – 15kW
- OLED graphic display
- Input power supply 3 x 400V 50-60Hz
- Pump voltage 3 x 400V
- Electric pump nominal frequency 50-200 Hz
- Control range in accordance with the sensor utilised, with standard range of 1-24bar
- Protections against voltage surges
- Adjustable overload protection
- Built-in flow sensor
- Extended connectivity
- Protection rating: IP20
- Dry run protection
- Short circuit between output phases
- Overtemperature protection
- Anti-seize and anti-frost function
- Facility to create booster sets with up to 8 inverters

| Model | Max. motor current A | Max. motor power kW | Power supply V | Pump Input V | Parallel user interface | Maximum dimensions L x H x P |
|----------------------|-------------------------|------------------------|---------------------|----------------------|-------------------------|---------------------------------|
| AD M/T 1.0 AC | 6.5 | 1 | Mono-phase 1x230 | Three-phase 3x230 | YES | 173 x 280 x 180 |
| AD M/T 1.5 AC | 9 | 1.5 | Mono-phase 1x230 | Three-phase 3x230 | YES | 173 x 280 x 180 |
| AD M/T 2.2 AC | 11.5 | 2.2 | Mono-phase 1x230 | Three-phase 3x230 | YES | 173 x 280 x 180 |

| | | AD M/T 1.0 AC | AD M/T 1.5 AC | AD M/T 2.2 AC |
|---|---|------------------------------------|---------------|---------------|
| Inverter power feeding | Voltage [VAC] (Tolerance +10/-20%) | 220-240 | | |
| | Phases | 1 | | |
| | Frequency [Hz] | 50 - 60 Hz | | |
| | Current [A] | 12 | 18,7 | 25 |
| Inverter power output | Voltage [VAC] (Tolerance +10/-20%) | 0 - V power supply | | |
| | Phases | 3 | | |
| | Frequency [Hz] | 0-200 | | |
| | Current [A] | 6,5 | 9 | 11,5 |
| | Max electrical power output [kVA] (400 Vrms) | 1,5 | 2,5 | 3,5 |
| Mechanical power rating P2 | 1 CV / 0,75 kW | 2 CV / 1,5 Kw | 3 CV / 2,5 kW | |
| Mechanical characteristics | Unit weight [kg] (packing included) | 6,3 | | |
| | Maximum dimensions [mm] (WxHxD) | 173 x 280 x 180 | | |
| Installation | Operating position | Any position | | |
| | IP protection rating | 20 | | |
| | Maximum ambient temperature [°C] | 50 | | |
| | Maximum conductor section accepted by input and output terminals [mm ²] | 4 | | |
| | Minimum cable diameter accepted by inlet and outlet cable glands [mm] | 6 | | |
| Maximum cable diameter accepted by inlet and outlet cable glands [mm] | 12 | | | |
| Control and operation hydraulic characteristics | Pressure control range [bar] | 1 – 95% pressure sensor full scale | | |
| | Options | Sensore di flusso | | |

| | | AD M/T 1.0 AC | AD M/T 1.5 AC | AD M/T 2.2 AC |
|---------------------------|-----------------------------------|---|---------------|---------------|
| Sensors | Types of pressure sensor | Ratiometric sensor - 4:20 mA | | |
| | Pressure sensors full scale [bar] | 16 / 25 / 40 | | |
| | Type of flow sensor supported | Pulses 5 [Vpp] | | |
| Functions and protections | Connectivity | Serial interface - Multi inverter connection | | |
| | Protections | - Dry-run - Overload protection on output phases - Internal electronics temperature protection - Anomalous power supply voltages - Direct short circuit between output phases - Pressure sensor fault | | |

TECHNICAL DATA

AD T/T 3.0 AC – AD T/T 4.0 AC - AD T/T 5.5 AC



| Model | Max. motor current A | Max. motor power kW | Power supply V | Pump Input V | Parallel user interface | Maximum dimensions L x H x P |
|----------------------|-------------------------|------------------------|----------------------|----------------------|-------------------------|---------------------------------|
| AD T/T 3.0 AC | 9 | 3 | Three-phase 3x400 | Three-phase 3x400 | YES | 251 x 370 x 180 |
| AD T/T 4.0 AC | 11 | 4 | Three-phase 3x400 | Three-phase 3x400 | YES | 251 x 370 x 180 |
| AD T/T 5.5 AC | 15 | 5.5 | Three-phase 3x400 | Three-phase 3x400 | YES | 251 x 370 x 180 |

| | | AD T/T 3.0 AC | AD T/T 4.0 AC | AD T/T 5.5 AC |
|---|---|------------------------------------|---------------|---------------|
| Inverter power feeding | Voltage [VAC] (Tolerance +10/-20%) | 380-480 | | |
| | Phases | 3 | | |
| | Frequency [Hz] | 50 - 60 Hz | | |
| | Current [A] | 12,5 - 10 | 16 - 12 | 20,5 - 16,5 |
| Inverter power output | Voltage [VAC] (Tolerance +10/-20%) | 0 - V power supply | | |
| | Phases | 3 | | |
| | Frequency [Hz] | 0-200 | | |
| | Current [A] | 12,5-10,0 | 16-12,0 | 20,5-16,5 |
| | Max electrical power output [kVA] (400 Vrms) | 5 | 6,5 | 9 |
| Mechanical power rating P2 | 4 CV/3.0 Kw | 5,5 CV/4.0 Kw | 7,5 CV/5.5 Kw | |
| Mechanical characteristics | Unit weight [kg] (packing included) | 11 | | |
| | Maximum dimensions [mm] (WxHxD) | 251 x 370 x 180 | | |
| Installation | Operating position | Any position | | |
| | IP protection rating | 20 | | |
| | Maximum ambient temperature [°C] | 50 | | |
| | Maximum conductor section accepted by input and output terminals [mm ²] | 4 | | |
| | Minimum cable diameter accepted by inlet and outlet cable glands [mm] | 11 | | |
| Maximum cable diameter accepted by inlet and outlet cable glands [mm] | 17 | | | |
| Control and operation hydraulic characteristics | Pressure control range [bar] | 1 – 95% pressure sensor full scale | | |
| | Options | Sensore di flusso | | |

| | | AD T/T 3.0 AC | AD T/T 4.0 AC | AD T/T 5.5 AC |
|---------------------------|-----------------------------------|---|---------------|---------------|
| Sensors | Types of pressure sensor | Ratiometric sensor - 4:20 mA | | |
| | Pressure sensors full scale [bar] | 16 / 25 / 40 | | |
| | Type of flow sensor supported | Pulses 5 [Vpp] | | |
| Functions and protections | Connectivity | Serial interface - Multi inverter connection | | |
| | Protections | - Dry-run - Overload protection on output phases - Internal electronics temperature protection - Anomalous power supply voltages - Direct short circuit between output phases - Pressure sensor fault | | |

| Model | Max. motor current A | Max. motor power kW | Power supply V | Pump Input V | Parallel user interface | Maximum dimensions L x H x P |
|-----------------------|-------------------------|------------------------|----------------------|----------------------|-------------------------|---------------------------------|
| AD T/T 7.5 AC | 22 | 7,5 | Three-phase 3x400 | Three-phase 3x400 | YES | 265 x 390 x 228 |
| AD T/T 11.0 AC | 31 | 11 | Three-phase 3x400 | Three-phase 3x400 | YES | 265 x 390 x 228 |
| AD T/T 15.0 AC | 41 | 15 | Three-phase 3x400 | Three-phase 3x400 | YES | 265 x 390 x 228 |

| | | AD T/T 7.5 AC | AD T/T 11.0 AC | AD T/T 15.0 AC |
|---|--|---------------------------------------|----------------|----------------|
| Inverter power feeding | Voltage [VAC] (Tolerance +10/-20%) | 380-480 | | |
| | Phases | 3 | | |
| | Frequency [Hz] | 50 - 60 Hz | | |
| | Current [A] | 27 | 38 | 51 |
| Inverter power output | Voltage [VAC] (Tolerance +10/-20%) | 0 - V power supply | | |
| | Phases | 3 | | |
| | Frequency [Hz] | 0-200 | | |
| | Current [A] | 22 | 31 | 41 |
| | Max electrical power output [kVA] (400 Vrms) | 15 | 21 | 28 |
| | Mechanical power rating P2 | 10 CV / 7,5 kW | 15 CV / 11 Kw | 20 CV / 15 kW |
| Mechanical characteristics | Unit weight [kg] (packing included) | 16 | | |
| | Maximum dimensions [mm] (WxHxD) | 265 x 390 x 228 | | |
| Installation | Operating position | Any position | | |
| | IP protection rating | 20 | | |
| | Maximum ambient temperature [°C] | 50 | | |
| Control and operation hydraulic characteristics | Pressure control range [bar] | 1 – 95% pressure sensor full scale | | |
| | Options | Flow sensor Redundant pressure sensor | | |

| | | AD T/T 7.5 AC | AD T/T 11.0 AC | AD T/T 15.0 AC |
|---------------------------|-----------------------------------|--|----------------|----------------|
| Sensors | Types of pressure sensor | Ratiometric sensor - 4:20 mA | | |
| | Pressure sensors full scale [bar] | 16 / 25 / 40 | | |
| | Type of flow sensor supported | Pulses 5 [Vpp] | | |
| Functions and protections | Connectivity | Serial interface - Multi inverter connection | | |
| | Protections | -- Dry-run - Overload protection on output phases - Internal electronics temperature protection - Anomalous power supply voltages - Direct short circuit between output phases - Pressure sensor fault | | |

Reducing motor speed, even marginally, can lead to an appreciable reduction in power consumption because the absorbed power of an electric motor is proportional to the rpm cubed. For example, a pump powered by the mains that runs at approximately 2950 rpm, will run approximately 20% slower (i.e. at 2360 rpm) when fed with a 40 Hz supply, leading to a saving of 40% in terms of absorbed power.

The motor speed reduction increases pump life significantly, thanks to the reduction of mechanical stress.

Pump performance in relation to variations in rpm

Pump rpm n has a very significant influence on pump performance. In the absence of cavitation phenomena the law of similarity is applicable, as shown in equation 1.

- Flow rate changes in a linear manner with changes in speed.
- Pressure changes in a squared relationship with changes in rpm.
- Power changes in a cubed relationship with changes in rpm.
- A small change in rpm produces a very large change in power.

Equation 1

$$\frac{Q_x}{Q} = \frac{n_x}{n} \quad Q = Q_x \frac{n_x}{n}$$

$$\frac{H_x}{H} = \left(\frac{n_x}{n}\right)^2 \quad H_x = H \left(\frac{n_x}{n}\right)^2$$

$$\frac{P_x}{P} = \left(\frac{n_x}{n}\right)^3 \quad P_x = P \left(\frac{n_x}{n}\right)^3$$

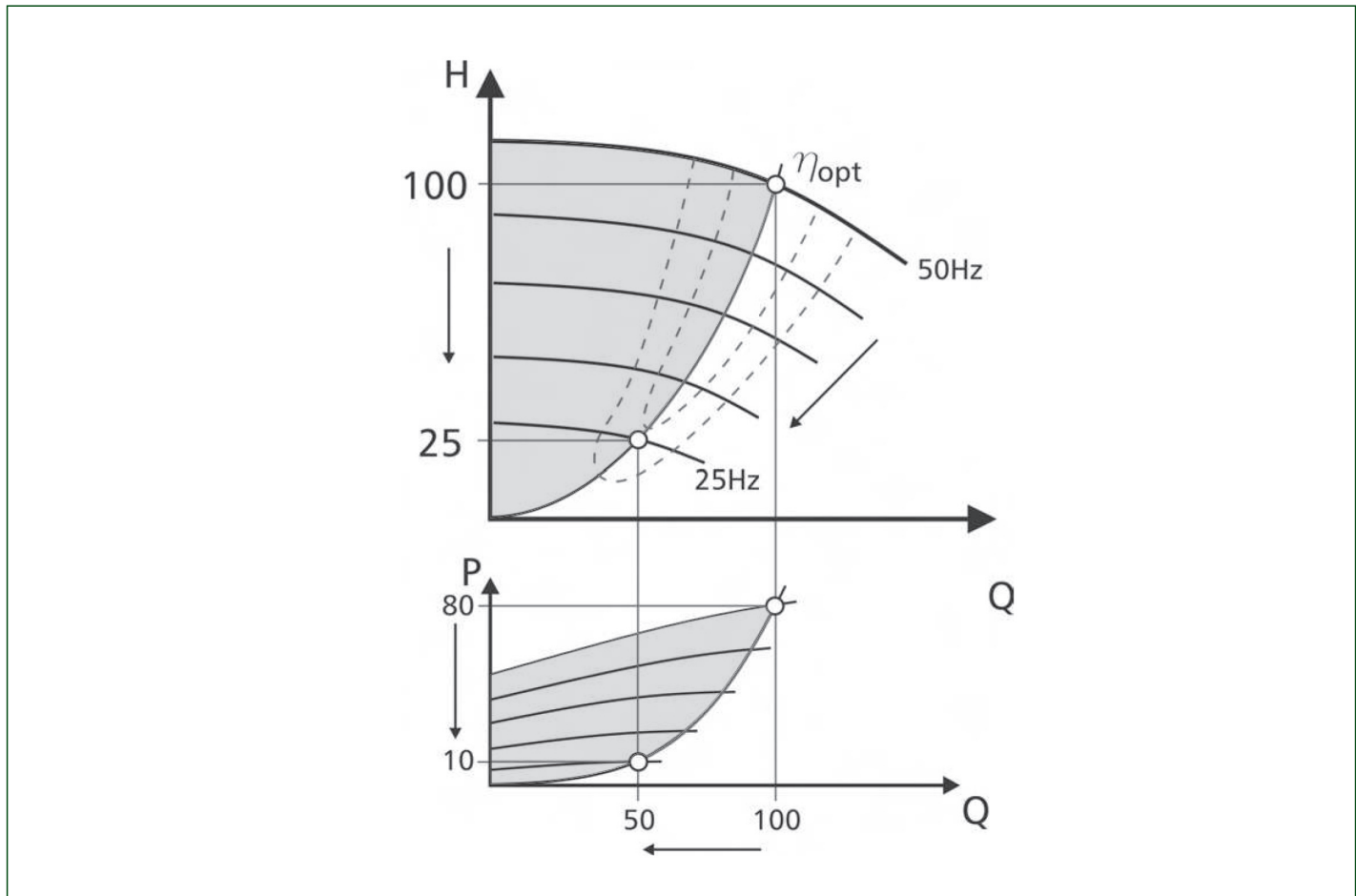

- a lowering of the flow acc. to the linear function
- a reduction of the head according to a quadratic function
- a reduction of the power consumption acc. to a cubic function!

AD M/T 1.0 AC – AD M/T 1.5 AC - AD M/T 2.2 AC

Example showing use of a 2,2 kW pump for 10 hours/day *

| Performance required of the pump | Minutes/day | Instantaneous power (ON/OFF) | Power with PWM | kWh (ON/OFF) | kWh (INVERTER) | kWh saved |
|----------------------------------|-------------|------------------------------|----------------|--------------|----------------|-------------|
| 0% - 20% | 30 | 1,32 | 0,50 | 0,66 | 0,25 | 0,41 |
| 20% - 30% | 30 | 1,32 | 0,50 | 0,66 | 0,25 | 0,41 |
| 30% - 40% | 60 | 1,37 | 0,55 | 1,37 | 0,55 | 0,82 |
| 40% - 50% | 240 | 1,41 | 0,60 | 5,66 | 2,39 | 3,27 |
| 50% - 60% | 120 | 1,54 | 0,69 | 3,08 | 1,38 | 1,70 |
| 60% - 70% | 54 | 1,82 | 0,94 | 1,64 | 0,85 | 0,79 |
| 70% - 80% | 30 | 2,04 | 1,30 | 1,02 | 0,65 | 0,37 |
| 80% - 90% | 24 | 2,17 | 1,76 | 0,87 | 0,70 | 0,16 |
| 90% - 100% | 12 | 2,20 | 2,07 | 0,44 | 0,41 | 0,03 |
| | | | TOT. | 15,39 | 7,44 | 7,95 |

YEARLY SAVING
7,95 kWh X 365 = **2902 kWh** / 2902 kWh X 0,2 € / kWh = **€ 580,34**

As we will see, in an average day of operation the MCE/P unit provides a **saving of 7,95 kWh**, equivalent to 60%, with respect to the consumption of a conventional on/off pump.

AD T/T 3.0 AC – AD T/T 4.0 AC - AD T/T 5.5 AC

Example showing use of a 5,5 kW pump for 10 hours/day *

| Performance required of the pump | Minutes/day | Instantaneous power (ON/OFF) | Power with PWM | kWh (ON/OFF) | kWh (INVERTER) | kWh saved |
|----------------------------------|-------------|------------------------------|----------------|--------------|----------------|--------------|
| 0% - 20% | 30 | 3,30 | 1,26 | 1,65 | 0,63 | 1,02 |
| 20% - 30% | 30 | 3,30 | 1,26 | 1,65 | 0,63 | 1,02 |
| 30% - 40% | 60 | 3,42 | 1,38 | 3,42 | 1,38 | 2,04 |
| 40% - 50% | 240 | 3,54 | 1,49 | 14,14 | 5,97 | 8,17 |
| 50% - 60% | 120 | 3,85 | 1,73 | 7,70 | 3,46 | 4,24 |
| 60% - 70% | 54 | 4,56 | 2,36 | 4,10 | 2,12 | 1,98 |
| 70% - 80% | 30 | 5,11 | 3,26 | 2,55 | 1,63 | 0,92 |
| 80% - 90% | 24 | 5,42 | 4,40 | 2,17 | 1,76 | 0,41 |
| 90% - 100% | 12 | 5,50 | 5,19 | 1,10 | 1,04 | 0,06 |
| | | | TOT. | 38,48 | 18,61 | 19,87 |

YEARLY SAVING
19,87 kWh X 365 = **7254 kWh**
7254 kWh X 0,2 € / kWh = **€ 1.450,85**

As we will see, in an average day of operation the MCE/P unit provides a **saving of 19,87 kWh**, equivalent to 60%, with respect to the consumption of a conventional on/off pump.

AD T/T 7.5 AC - AD T/T 11.0 AC - AD T/T 15.0 AC

Example showing use of a 15 kW pump for 10 hours/day *

| Performance required of the pump | Minutes/day | Instantaneous power (ON/OFF) | Power with PWM | kWh (ON/OFF) | kWh (INVERTER) | kWh saved |
|----------------------------------|-------------|------------------------------|----------------|---------------|----------------|--------------|
| 0% - 20% | 30 | 9,00 | 3,43 | 4,50 | 1,71 | 2,79 |
| 20% - 30% | 30 | 9,00 | 3,43 | 4,50 | 1,71 | 2,79 |
| 30% - 40% | 60 | 9,32 | 3,75 | 9,32 | 3,75 | 5,57 |
| 40% - 50% | 240 | 9,64 | 4,07 | 38,57 | 16,29 | 22,29 |
| 50% - 60% | 120 | 10,50 | 4,71 | 21,00 | 9,43 | 11,57 |
| 60% - 70% | 54 | 12,43 | 6,43 | 11,19 | 5,79 | 5,40 |
| 70% - 80% | 30 | 13,93 | 8,89 | 6,96 | 4,45 | 2,52 |
| 80% - 90% | 24 | 14,79 | 12,00 | 5,91 | 4,80 | 1,11 |
| 90% - 100% | 12 | 15,00 | 14,14 | 3,00 | 2,83 | 0,17 |
| | | | TOT. | 104,96 | 50,75 | 54,20 |

As we will see, in an average day of operation the MCE/P unit provides a **saving of 54,20 kWh**, equivalent to 60%, with respect to the consumption of a conventional on/off pump.

YEARLY SAVING
54,20 kWh X 365 = **19784 kWh**
19784 kWh X 0,2 € / kWh = **€ 3.956,86**

*The table shows a comparison of **daily consumption** of a standard pump driven by an On/Off system and a pump driven by a ADAC inverter.

1 Hydraulic diagram

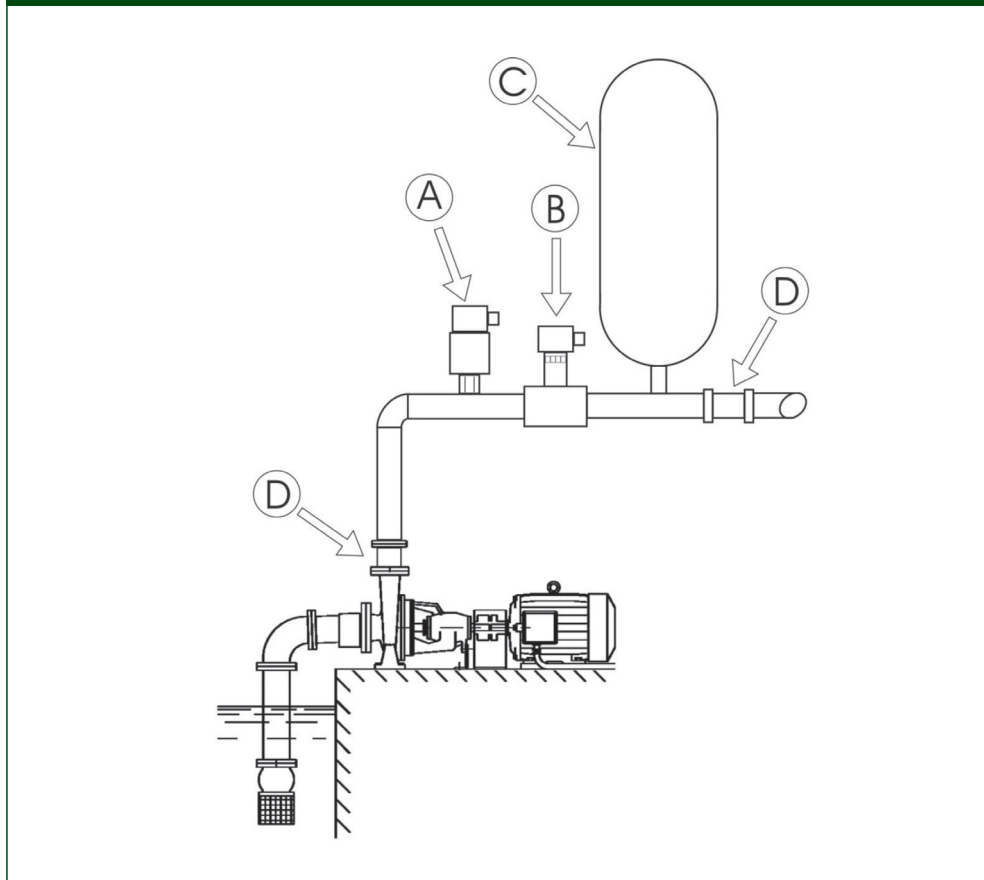

Parts that make up the system

- A Pressure sensor
- B Flow sensor
- C Gun barrel
- D Check Valve

The Picture 1 shows the scheme of a correct Hydraulic installation.

The ADAC is a panel inverter and is connected to the hydraulic section by means of pressure and flow sensors. The pressure sensor is always required, while the flow sensor is optional.

Both are mounted on pump delivery and connected by means of the relative cables to the respective inputs on the ADAC board.

Always fit a check valve on pump suction and an expansion vessel on pump delivery. In all circuits subject to the risk of water hammer (for example irrigation systems with flow rate interrupted suddenly by solenoid valves), fit a further check valve downline of the pump and mount the sensors and expansion vessel between the pump and valve.

The hydraulic connection between the pump and sensors must not have branched sections.

Pipelines must be sized according to the type of electric pump installed. Excessively deformable systems may generate oscillations; if this occurs, the user may solve the problem by adjusting control parameters "GP" and "GI".

Note: The ADAC system works at constant pressure. This setting is best exploited if the hydraulic system downline of the system is suitably sized. Systems with excessively small pipelines can cause pressure drops for which the equipment is unable to compensate; the result is constant pressure on the sensors but not on the utility.

Foreign bodies in the pipeline: the presence of dirt in the fluid may obstruct transfer channels, block the flow or pressure sensor and impair correct system operation. Take care to install the sensors so that they are not subject to the build-up of excessive sediment or air bubbles that may impair operation. If the size of the pipeline enables transit of foreign bodies, a special filter may need to be installed.

Connection to the power line

The ADAC must be connected to the power line by means of a 3-core cable (2 phases+earth).

The input terminals are those marked with the text LN and an arrow pointing towards the terminals.

The section, type and laying of cables for inverter power supply and electric pump connections must be selected in compliance with current standards. Table 2: Cable sections provides indications on the cable section to be used.

The table refers to cables in PVC with 4 wires (3 phases + earth) with the minimum recommended section based on the current and length of cable.

The electric pump current is normally specified on the motor dataplate. The current supply to the ADAC can normally be calculated (taking a safety margin into account) as 1/3 of the current absorbed by the pump. Although the ADAC is already equipped with internal safety devices, the installation of a suitably sized thermal magnetic circuit breaker is recommended.

If the entire power range available is used, for specific information on the current to be used when choosing cables and the thermal magnetic circuit breaker.

 **The thermal magnetic circuit breaker and power cables of the ADAC and pump must be sized according to the system; if the specifications in the manual do not correspond to provisions of current standards, use only the latter as a reference.**



Connection to pump (only for series AD M/T 1.0 AC – M/T 1.5 AC- M/T 2.2 AC)

The power supply voltage of the installed electric pump must be 230 V three-phase. Three-phase electrical machinery generally has 2 types of connection, as shown in Figure 3 and Figure 4

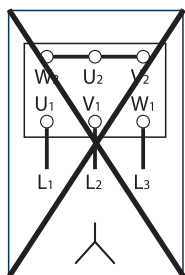

3 Incorrect connection

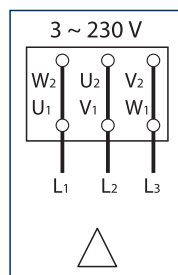

4 Correct connection

The delta connection is the one typically used for working at 230 V (lower voltage).

For versions not supplied with the cable, the connection is on the 4-way terminal marked "PUMP" and with the arrow on output. The minimum cable section must be 1.5 mm².



Incorrect connection of the earth lines to a terminal other than the earth terminal may cause irremediable damage to the whole appliance!

Incorrect connection of the power supply line on output terminals intended for the load may cause irremediable damage to the whole appliance!

Connection of sensors

The terminations for sensor connections are on the lower right section and are accessible by removing the screw of the connections cover. Cover removal for access to connections. The sensors must be connected to the relative inputs marked "Press" and "Flow".

Connecting the flow sensor (Optional)

The flow sensor is supplied with its own cable. One end of the cable must be connected to the sensor and the other end to the relative inverter flow sensor input, marked "Flow 1"; see Figure 2 pag. 9: Connections.

The cable has two different terminals with compulsory direction of insertion: connector for industrial applications (DIN 43650) on the sensor side and 6-pole connector on the ADAC side.

Note: the flow sensor and pressure sensor are both fitted with a DIN 43650 type connector, and therefore take care to ensure the correct sensor is connected to the correct cable.

Connecting a ratiometric sensor

One end of the cable must be connected to the sensor and the other end to the relative inverter pressure sensor input, marked "Press 1".

The cable has two different terminals with compulsory direction of insertion: connector for industrial applications (DIN 43650) on the sensor side and 4-pole connector on the ADAC side.

2 Sensors connection

ADAC T/T 1.0 - ADAC T/T 1.5 - ADAC M/T 2.2

- A PRESSURE SENSOR (REQUIRED)
- B FLOW SENSOR (OPTIONAL)

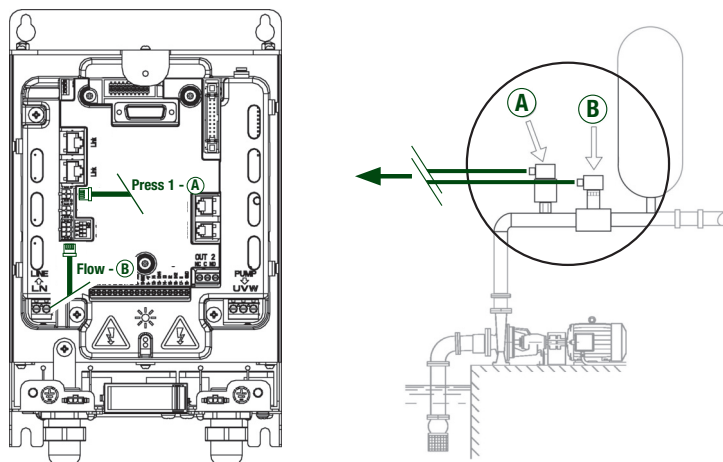

2 Sensors connection

ADAC T/T 3.0 - ADAC T/T 4.0 - ADAC T/T 5.5

- A PRESSURE SENSOR (REQUIRED)
- B FLOW SENSOR (OPTIONAL)

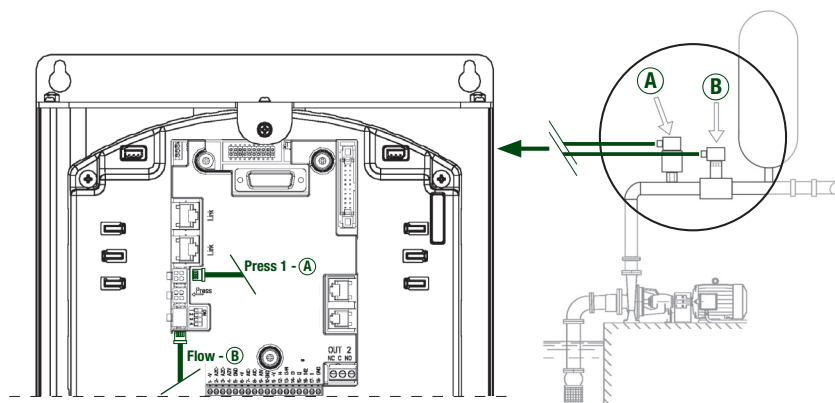

2 Sensors connection

ADAC T/T 7.5 - ADAC T/T 11 - ADAC T/T 15

- A PRESSURE SENSOR (REQUIRED)
- B FLOW SENSOR (OPTIONAL)

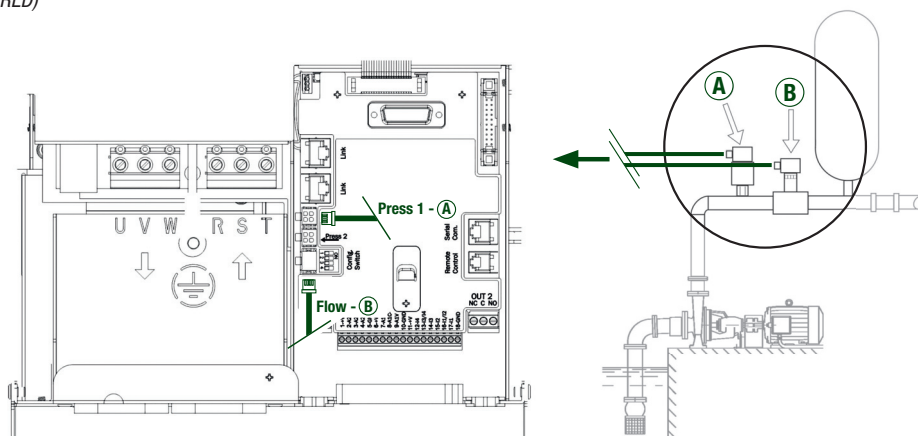

The ADAC series of inverters can identify flow in accordance with three different methods:

- By means of the flow sensor
- Self-adaptive mode (without Flow Sensor)
- Manual mode (without Flow Sensor)

By means of the flow sensor:

The flow is detected by a flow sensor; this maximises performance and efficiency. The flow is read directly by the flow sensor, so that the system responds in reliable times to any variation of conditions that occurs in the system.

For example: in the absence of water, the system will stop the pump precisely within the time set in parameter *tb* (trip time).

To set this algorithm correctly, set the type of sensor utilised, parameter *FI*, and the diameter of the piping, parameter *FD*

Self-Adaptive Mode (Without Flow Sensor)

This mode is composed of the use of a specific and highly effective self-adaptive algorithm.

The algorithm acquires information and updates its parameters during operation. To achieve optimal operation ensure that the hydraulic installation is not subject to modifications that result in a significant variation in its characteristics (such as, for example, solenoid valves that switch between hydraulic sectors with very different characteristics) during normal operation, because the algorithm will set up to match one of the conditions and may not give the required results when the changeover occurs. In contrast, no problems exist if the installation characteristics are substantially unchanged (length, elasticity and required minimum flow rate). There is also no problem if the inverter is restarted after the installation has been modified. This is because the acquired values are reset every time the system is restarted or reset.

The adaptation procedure takes up to 3-4 hours, and during this period the algorithm will switch off the inverter to attempt to read the hydraulic flow rate. The operation can be speeded up by using the fast teach-in method for self-adaptive mode (refer to the manual)

The algorithm utilised measures various significant parameters and analyses the unit status to detect the presence and magnitude of the flow. For this reason, and to avoid nuisance tripping, it is important to set up the parameters correctly; specifically, perform correct set-up of rated current *RC*; set adequate minimum flow *FT*, set correct minimum frequency *FL*, and set the correct direction of run.

Manual Mode

This completely manual mode makes it possible to set the frequency (*FZ*) below which flow is considered to be zero.

This means the pump will stop when the rotation frequency drops below *FZ* for the time set in parameter *T2* (trip time for zero flow).

 If *FZ* is too high, the pump may switch off even in the presence of a flow, and then switch on again as soon as the pressure falls below the restart pressure. This may lead to repeated stops and starts also in rapid succession.

 If *FZ* is too low, the pump may never switch off even in the absence of a flow or with very low flow rates. This situation may lead to damage of the pump due to overheating.

NOTE: Manual mode is the only mode available for pressure units without flow sensor.

QUICK START GUIDE

PUMP AND POWER SUPPLY CONNECTION



AD M/T 1.0 AC - AD M/T 1.5 AC- AD M/T 2.2 AC

A Installation

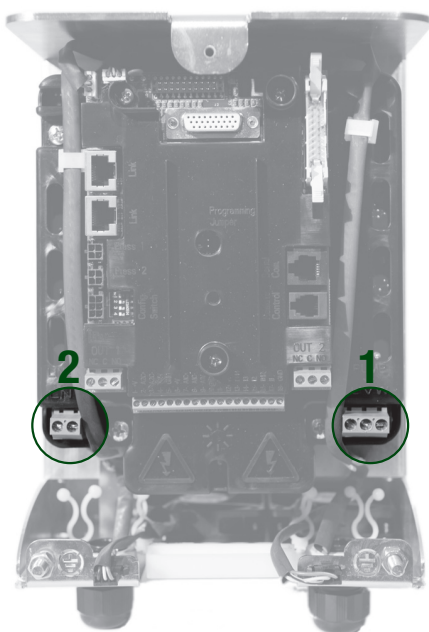

- 1 Connect the power supply to the MCE/P
- 2 Connect eletrically the MCE/P

AD T/T 3.0 AC - AD T/T 4.0 AC- AD T/T 5.5 AC

A Installation

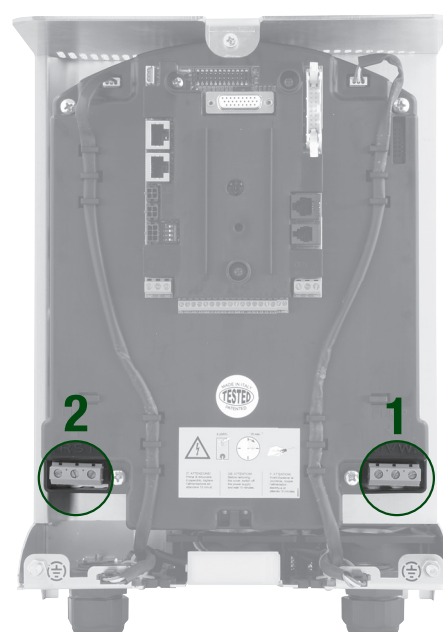

- 1 Connect the power supply to the MCE/P
- 2 Connect eletrically the MCE/P

AD T/T 7.5 AC- AD T/T 11.0 AC - AD T/T 15.0 AC

A Installation



- 1 Connect the power supply to the MCE/P
- 2 Connect eletrically the MCE/P

B | Sensors installation (OPTIONAL)

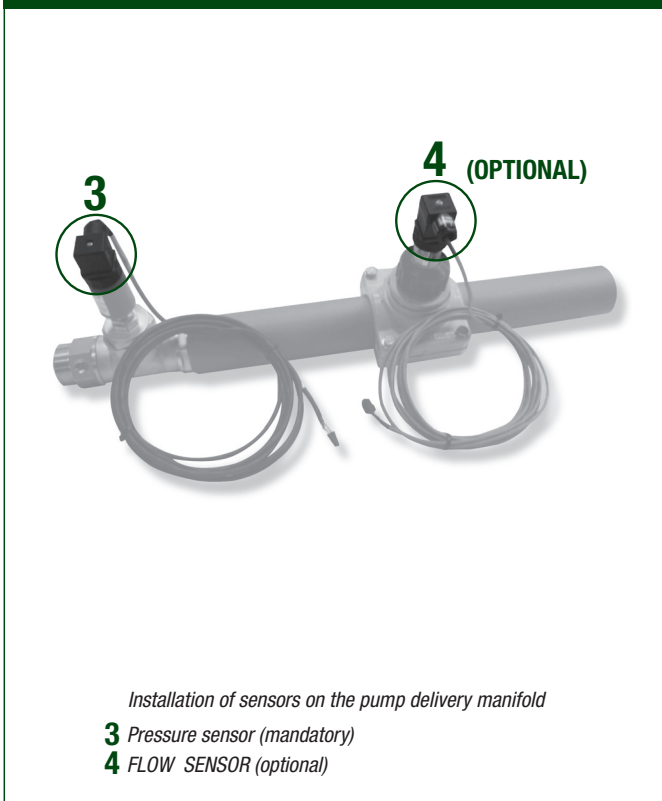

Installation of sensors on the pump delivery manifold

- 3** Pressure sensor (mandatory)
- 4** FLOW SENSOR (optional)

7. How to program the ADAC

Then the end user should close the front cover.

8. Switch on the power supply

Next step is to fix the amperometric protection. Press for 5 seconds:



On the screen appears the value **RC**
Adjust the amperage with ∇ and \blacktriangle .

9. Direction of Rotation of the motor

Press two times



On the screen appears the parameter **RT** And with the ∇ and \blacktriangle select the direction of rotation.

To choose the correct direction of rotation, the end user could do in the following way: after opening one tap, the end user could check on the display the value of the frequency (FR). The right direction of rotation is the one that gives to lower FR value.

10. Flow sensor

IF THE FLOW SENSOR IS INSTALLED - Press



until it is not achieved the parameter **FD**. (Pipe dimension).
Choose the value of the pipe diameter where the sensor is assembled.

IF THE FLOW SENSOR IS NOT INSTALLED - Press



until it is not achieved the parameter **FL**. Fix this parameter, so that the flow sensor is absent.

11. Set point

Press  to exit from Installer's menu.

Press   for 2 seconds and adjust the pressure.

SP is displayed; use keys ∇ and \blacktriangle to set the pressure

C | Connection of the sensor to the MCE/P

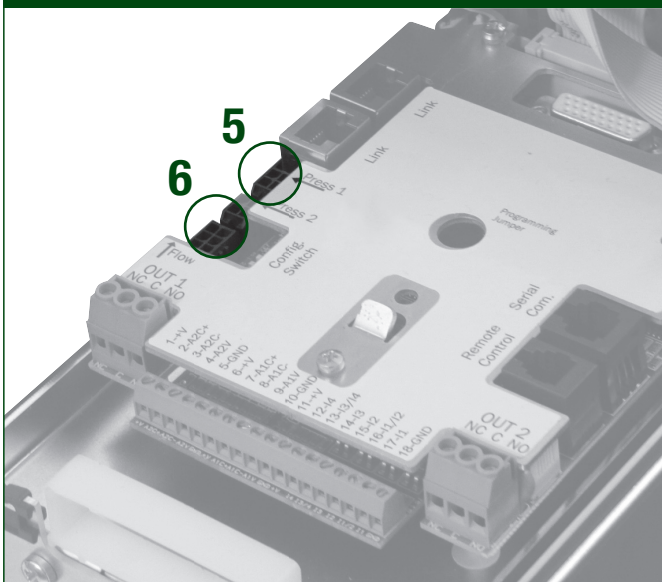

- 5** PRESSURE SENSOR With 4 poles connector to press 1.
The pressure sensor is mandatory.
- 6** FLOW SENSOR with 6 poles connector (only if installed).
The flow sensor is optional.



Fig. 6 Performance curves without inverter

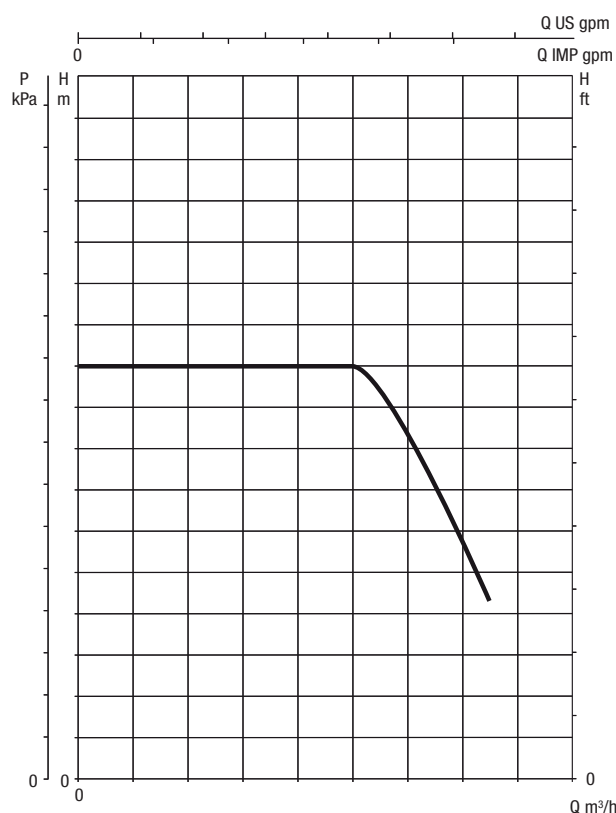

Fig. 7 Performance curves with inverter

PERFORMANCE CURVE

When an inverter is installed the performance curve changes as shown in figure 7.

The inverter can maintain constant pressure as flow rate changes.

Working pressure can be regulated by the user.

A good pressure set-point is between 1/3 and 2/3 of the maximum pump pressure head. This serves to maintain a high level of pump efficiency while maximising power savings.

Note: The ADAC inverter does not stop the pump if the pressure value is not reached although a flow is detected.

This strategy prevents service outages in the case of high flow applications.

PROTECTION SYSTEMS

ADAC is equipped with protection systems designed to preserve the pump, motor, power line and ADAC itself. When one or more protections trip, the one with the highest priority is shown on display. Depending on the type of error, the electric pump may shut down, but when normal conditions are restored, the error state may clear automatically, immediately or after a set time interval following automatic reset.

In the case of a block due to water supply failure (BL), block due to pump motor current overload (OC), block due to final output stage current overload (OF), block due to direct short circuit between the phases on the output terminal (SC), the user can attempt to manually reset the error condition by pressing and releasing buttons + and - simultaneously. If the error condition persists, the cause of the fault must be located and eliminated.

WARNING ON THE FAULT HISTORY QUEUE

| DISPLAY | DESCRIPTION |
|---------|------------------------------|
| PD | IRREGULAR SHUTDOWN |
| FA | PROBLEMS WITH COOLING SYSTEM |

ERROR CONDITIONS

| DISPLAY | DESCRIPTION |
|---------|---|
| bL | BLOCKAGE DUE TO LACK OF WATER |
| bP | BLOCK DUE TO PRESSURE SENSOR READING ERROR |
| LP | BLOCKAGE DUE TO LOW SUPPLY VOLTAGE |
| HP | BLOCK DUE TO HIGH INTERNAL POWER SUPPLY VOLTAGE |
| ot | BLOCKAGE DUE TO OVERHEATING OF THE POWER OUTPUT STAGES |
| ob | BLOCKAGE DUE TO OVERHEATING OF THE PRINTED CIRCUIT |
| oC | BLOCKAGE DUE TO OVERCURRENT IN THE ELECTRO PUMP MOTOR |
| oF | BLOCKAGE DUE TO OVERCURRENT IN THE OUTPUT STAGES |
| SC | BLOCKAGE DUE TO DIRECT SHORT CIRCUIT BETWEEN THE PHASES OF OUTPUT TERMINALS |
| EC | BLOCKAGE DUE TO INCORRECT SETTING OF THE RATED CURRENT (RC) |
| Ei | BLOCK DUE TO "I" INTERNAL ERROR |
| Vi | BLOCK DUE TO "I" INTERNAL VOLTAGE OUTSIDE TOLERANCE |

AUTOMATIC RESET OF ERROR CONDITIONS

| DISPLAY | DESCRIPTION | SEQUENCE OF AUTOMATIC RESET |
|---------|---|---|
| bL | Blockage due to lack of water | One attempt every 10 min. for a total of 6 attempts - One attempt every 1 hour for a total of 24 attempts - One attempt every 24 hours for a total of 30 attempts |
| bP | Shutdown due to fault of the pressure sensor | - Reset 10 seconds after correct conditions return |
| LP | Shutdown due to low supply voltage $V_n - 20\%$ | - Reset when line voltage over $V_n - 15\%$ is restored |
| HP | Shutdown due to high voltage, $V_n + 15\%$ | - Reset when line voltage less than $V_n + 15\%$ is restored |
| Ot | Shutdown due to overheating of the power stages ($T_E > 100$) | - Reset when the temperature of the power stages falls below 85°C again |
| ob | Shutdown due to overheating of the printed circuit ($BT > 120^\circ\text{C}$) | - Reset when the temperature of the printed circuit falls below 100°C again |
| OC | Shutdown due to current overload | - An attempt every 10 minutes for a total of 6 attempts |
| oF | Shutdown due to current overload in the output stages | - An attempt every 10 minutes for a total of 6 attempts |

PROTECTION SYSTEMS
"bL" Block due to water failure

In zero flow conditions, with pressure lower than the set regulation value, a water failure signal is emitted and the system shuts down the pump. The delay interval without pressure and flow can be set in the parameter TB of the TECHNICAL ASSISTANCE menu.

If the user inadvertently enters a pressure setpoint higher than the pressure that the electric pump can supply on closure, the system indicates "block due to water failure" (BL) even if this is not precisely the problem. In this case, lower the regulation pressure to a reasonable value, which does not normally exceed 2/3 of the head of the electrical pump installed.

"bP" Block due to fault on pressure sensor

If ADAC detects a fault on the pressure sensor, the pump remains blocked and the error signal "BP" is displayed. This status starts as soon as the problem is detected and is reset automatically when the correct conditions are restored.

"LP" Block due to low power supply voltage

This occurs when the voltage on the line to the power supply terminal falls below 164 Vac. Reset is only automatic when the voltage to the terminal exceeds 184 Vac.

"HP" Block due to high internal power supply voltage

This occurs when the internal power supply voltage has values outside the specified range. Reset is only automatic when the voltage returns to within admissible values. This may be caused by changes in power supply voltage or excessively sudden pump shutdown.

"SC" Block due to direct short circuit between the phases on the output terminal

ADAC is equipped with a protection against direct short circuits, which may occur between the phases U, V, and W of the output terminal "PUMP". When this block signal is sent, the user can attempt reset by pressing buttons + and - simultaneously which in any event does not have any effect until 10 seconds has passed since the moment of the short circuit.

3 Groups for inverters

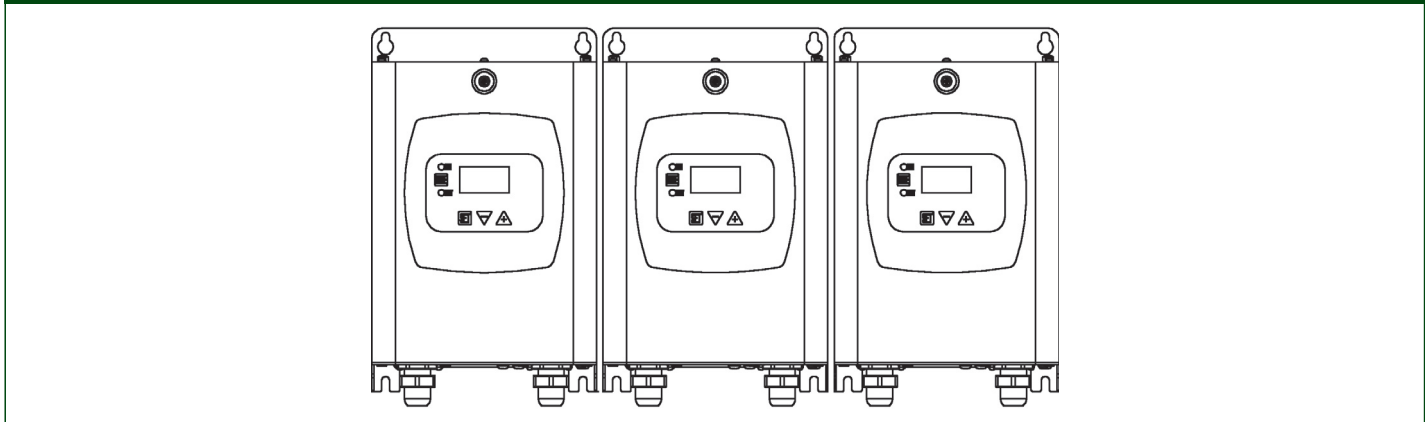

Introduction to multi inverter systems

A multi inverter system comprises a pump set made up of a series of pumps with delivery outlets all conveying to a single manifold. Each pump of the set is connected to its own inverter and the various inverters communicate via a special connection (Link).

The maximum number of pump-inverter elements possible in a group is 8.

A multi inverter system is mainly used to:

- Increase the hydraulic performance with respect to a single inverter
- Ensure operation continuity in the event of a fault on a pump or inverter
- Partition maximum power

Setting up a multi inverter system

The pumps must all be connected to a single delivery manifold and the flow sensor must be placed on the outlet of the latter to read the flow to the entire pump set. In the case of using multiple flow sensors, these must be installed on the delivery of each pump.

The pressure sensor must be connected to the outlet manifold. If more than one pressure sensor is used, these must also be installed on the manifold or in any event on a pipeline that is connected to it.

Note: If multiple pressure sensors are read, take care that the pipeline on which they are mounted is not equipped with non-return valves between one sensor and the next; otherwise different pressure values may be read which lead to false average readings and incorrect settings.

For optimal operation of the pressure set, the following must be the same for each inverter-pump pair:

- type of pump and motor
- hydraulic connections
- rated frequency
- minimum frequency
- maximum frequency

Although this is the optimal condition, some of the above parameters may differ.

Sensors

The sensors to be connected are the same versions used in stand-alone versions, i.e. pressure sensor and flow sensor.

Flow sensors (OPTIONAL)

The flow sensors are optional and can be connected in two ways:

- one sensor only
- the same number of sensors as inverters

The setting is entered on parameter FI. No other types of system are admitted.

The single flow sensor must be installed on the delivery manifold and it must intercept the hydraulic flow of the entire booster set. The electrical connection can be made independently on any of the inverters.

Multiple sensors are useful when a specific flow rate is required on each pump, and enhance protection against dry running operation. To use multiple flow sensors, parameter FI must be set to multiple sensors and each flow sensor must be connected to the inverter that controls the pump delivery where the sensor is located.

Pressure sensors

The pressure sensor must be inserted on the delivery manifold. There can be more than one pressure sensor, and in this case the pressure reading will be the average value of all those present. To use multiple pressure sensors, the connectors are simply inserted in the relative inputs and no parameter needs to be set. The number of pressure sensors installed can vary as required between one and the maximum number of inverters present.

Multi-inverter settings

When a multi inverter system is switched on, the addresses are assigned automatically and, by means of an algorithm, an inverter is nominated as the settings leader. The leader decides on the frequency and order of start-up of each inverter in the series.

The settings mode is sequential (inverters start one at a time). When start-up conditions are enabled, the first inverter starts, and when this reaches maximum frequency, the next one starts, and so on. The order of start-up is not necessarily ascending according to the machine address, but depends on the hours of operation.

When the minimum frequency FL is used, and there is only one inverter operative pressure surges may occur. Depending on the case, pressure surges may be inevitable and may occur at the minimum frequency when this value, in relation to the hydraulic load, causes a pressure level greater than the required value. On multi inverter systems, this problem remains limited to the first pump that is started up, as on the subsequent pumps the situation is as follows: when the previous pump reaches the maximum frequency, the next one starts up at the minimum frequency to then reach the maximum frequency. When the frequency of the pump at maximum is reduced (obviously through to the minimum frequency limit) the pump activation overlaps, which while observing minimum frequency rates, does not cause pressure surges.

Assigning the start-up order

Each time the system is activated, each inverter is associated a starting order. This setting establishes the order of inverter start-up.

The starting order is modified during use according to requirements, by the two following algorithms:

- Reaching of maximum operating time
- Reaching of maximum inactivity time

Maximum operating time

According to parameter ET (maximum operating time), each inverter has an hour counter, and the starting order is updated on the basis of these values according to the following algorithm:

- if at least half of the value ET is exceeded, priority is changed on the first shutdown of the inverter (switch to standby).
- if the value ET is reached without stopping, the inverter stops unconditionally and this sets to the minimum restart priority (switch during operation).

Reaching of maximum inactivity time

The multi inverter system has an anti-stagnant algorithm that is aimed at maintaining pump efficiency and integrity of the pumped liquid. It acts by enabling rotation of the pump starting order to ensure a delivery to all pumps of at least one minute of flow every 23 hours. This is implemented regardless of the inverter configuration (enabled or reserve). Priority switch envisages that the inverter stationary for 23 hours is set to maximum priority in the starting order. This means that it is the first to be started up as soon as flow delivery is required. The inverters configured as reserve have priority over the others. The algorithm terminates action when the inverter has delivered at least one minute of flow.

After the anti-stagnant interval, if the inverter is configured as reserve,

it is set to minimum priority to avoid premature wear.

Reserves and number of inverters involved in pumping

The multi inverter system reads how many elements are connected in communicating mode and calls this number N.

Then, on the basis of parameters NA and NC it decides how many and which inverters must work at a given time.

NA represents the number of inverters involved in pumping NC represents the maximum number of inverters that can run simultaneously.

In a series, if there are NA active inverters and NC simultaneous inverters, when NC is less than NA, this means that a maximum of NC inverters will start up simultaneously, and these will switch between NA elements. If an inverter is configured with reserve priority, it will set as last in the starting order, therefore for example, if there are 3 inverters and one of these is configured as reserve, the reserve unit will start in third place; otherwise if set to NA=2 the reserve will not start up unless one of the two active units sets to fault status.

A Installation



- 1 Connect the power supply to the MCE/P
- 2 Connect electrically the MCE/P

B Link connection

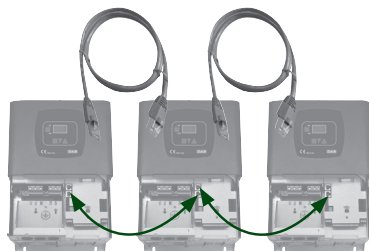

- 3 Connect with the cable each MCE/P
It is possible to insert in every input link.

C Sensors installation (OPTIONAL)

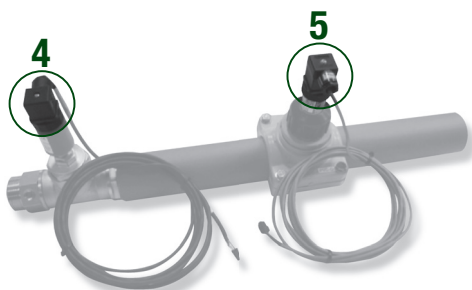

- Installation of sensors on the pump delivery manifold
- 4 Pressure sensor (mandatory)
 - 5 FLOW SENSOR (optional)

C Connection of the sensor to the MCE/P

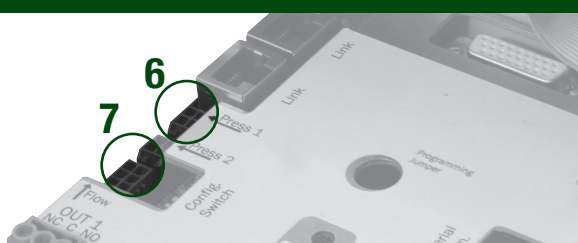

- 6 PRESSURE SENSOR With 4 poles connector to press 1.
- 7 FLOW SENSOR with 6 poles connector (OPTIONAL).

8. How to program the ADAC

Then the end user should close the front cover and switch on the power supply **To only one inverter at time.**

9. Fix the amperometric protection

Press for 5 seconds:



On the screen appears the value **RC**
Adjust the amperage with ∇ and \triangle .
You can read the rated current in the label of the pump.

10. Direction of Rotation of the motor

Press

On the screen appears the parameter **RT** and with the ∇ and \triangle select the direction of rotation. To choose the correct direction of rotation, the end user could do in the following way: after opening one tap, the end user could check on the display the value of the frequency (FR). The right direction of rotation is the one that gives to lower FR value.

11. Flow sensor (OPTIONAL)

- IF THE FLOW SENSOR IS INSTALLED - Press many times



finche non viene visualizzato il parametro dimensione del tubo in Pollici **FD**
selezionare il diametro della tubatura dove è installato il sensore di flusso.

- SENSORE DI FLUSSO ASSENTE Premere tante volte il tasto



until it is not achieved the parameter **FL** . (Pipe dimension). Choose the value of the pie diameter where the sensor is assembled.

12. press the key repeatedly until the FZ parameter is displayed; set the frequency of FZ shutdown, when the pumps should stop.

13. Set point.

Press to exit from Installer's menu on the first inverter.

Press for 2 seconds and adjust the pressure

SP is displayed; use keys ∇ and \triangle to set the pressure. Repeat the settings of RC, RT, FD, SP for each inverter, powering up only the inverter subject to settings.

14. Switch on the power supply on each ADAC

The system is ready to work normally. If necessary, change the other parameters as described on manual instruction.

ADAC systems are equipped with 4 inputs and 2 outputs to enable a number of solutions for interface with more complex installations.

Figure 11: Example of output connections and Figure 12: Example of input connections show examples of two possible configurations of the inputs and outputs.

For the installer it is sufficient to wire the required input and output contacts and then configure the functions as necessary.

Note: The +19 [Vdc] power supplies to pins 11 and 18 and J5 (18-pole terminal board) can deliver a maximum of 50 [mA].

Photocoupled input contact specifications

The connections of the inputs listed below refer to the 18-pole terminal board J5, with numbering starting from pin 1 from the left. The base of the terminal board also bears the text of the corresponding inputs.

- I 1: Pins 16 and 17
- I 2: Pins 15 and 16
- I 3: Pins 13 and 14
- I 4: Pins 12 and 13

The inputs can be activated in DC or AC.

11 Example of output connections

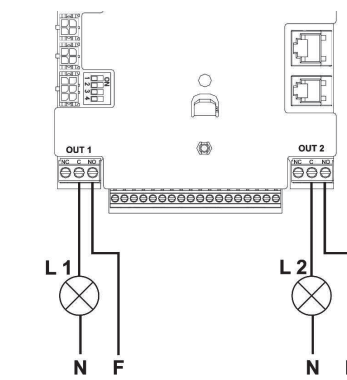

With reference to the example in Figure : Example of output connections and using the default settings (O1 = 2: contact NO; O2 = 2; contact NO) the following is obtained:

L1 lights up when the pump is blocked (e.g. "BL":water failure block).

L2 si accende quando la pompa è in marcia ("GO").

12 Example of input connections

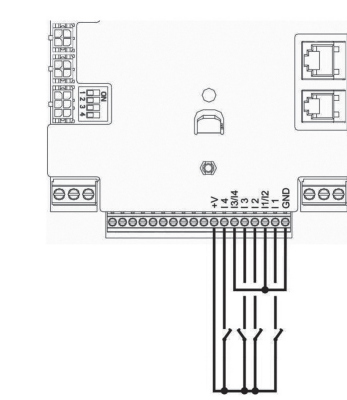

With reference to the example in Figure: Example of input connections and using the default input settings (I1 = 1; I2 = 3; I3 = 5; I4=10) the following is obtained: When the switch on I1 is turned off the pump blocks and the signal "F1 is displayed"

When the switch is closed on I2 the control pressure becomes "P2"

When the switch is closed on I3 the pump trips and error code "F3" is displayed

When the switch is closed on I4 after time T1 the pump trips and error code F4 is displayed.

Parameters

| MENUS AND DEFAULT VALUES | | | | |
|--|------------------------------------|--------------------|---------------|---------------|
| DESCRIPTION | | Factory parameters | | |
| Indications on the display in normal operation | | AD M/T 1.0 AC | AD M/T 1.5 AC | AD M/T 2.2 AC |
| LA | Language | ITA | ITA | ITA |
| SP | Setpoint pressure [bar] | 3,0 | 3,0 | 3,0 |
| P1 | Setpoint P1 [bar] | 2,0 | 2,0 | 2,0 |
| P2 | Setpoint P2 [bar] | 2,5 | 2,5 | 2,5 |
| P3 | Setpoint P3 [bar] | 3,5 | 3,5 | 3,5 |
| P4 | Setpoint P4 [bar] | 4,0 | 4,0 | 4,0 |
| FP | Test frequency in manual mode | 40,0 | 40,0 | 40,0 |
| RC | Rated current of electric pump [A] | 0,0 | 0,0 | 0,0 |
| RT | Direction of rotation | 0 (UWV) | 0 (UWV) | 0 (UWV) |
| FN | Rated frequency [Hz] | 50,0 | 50,0 | 50,0 |
| OD | Type of system | 1 (Rigid) | | |
| RP | Restart pressure [bar] | 0,5 | 0,5 | 0,5 |
| AD | Address | 0 (Auto) | | |
| PR | Pressure sensor | 1 (501 R 25 bar) | | |
| MS | Measurement system | 0 (International) | | |
| FI | Flow sensor | 1 (Flow X3 F3.00) | | |
| FD | Pipeline diameter [inch] | 2 | 2 | 2 |
| FK | K-factor [pulse/l] | 24,40 | 24,40 | 24,40 |

Parameters

| MENUS AND DEFAULT VALUES | | | | |
|--|---|--------------------|---------------|---------------|
| DESCRIPTION | | Factory parameters | | |
| Indications on the display in normal operation | | AD M/T 1.0 C | AD M/T 1.5 AC | AD M/T 2.2 AC |
| FZ | Minimum shutdown flow [l/min] | 0 | 0 | 0 |
| FT | Delay for water failure block [s] | 5 | 5 | 5 |
| SO | Dry running factor | 22 | 22 | 22 |
| MP | Minimum pressure pump stop [bar] | 0,0 | 0,0 | 0,0 |
| TB | Shutdown delay [s] | 10 | 10 | 10 |
| T1 | Shutdown time after low pressure signal | 2 | 2 | 2 |
| T2 | Shutdown delay [s] | 10 | 10 | 10 |
| GP | Proportional gain coefficient | 0,6 | 0,6 | 0,6 |
| GI | Integral gain coefficient | 1,2 | 1,2 | 1,2 |
| FS | Maximum rotation frequency [Hz] | 50,0 | 50,0 | 50,0 |
| FL | Minimum rotation frequency [Hz] | 0,0 | 0,0 | 0,0 |
| NA | Active inverters | N | N | N |
| NC | Simultaneous inverters | NA | NA | NA |
| IC | Reserve configuration | 1 (Auto) | 1 (Auto) | 1 (Auto) |
| ET | Exchange time [h] | 2 | 2 | 2 |
| CF | Carrier [kHz] | 5 | | |
| AC | Acceleration | 3 | | |
| AE | Anti-blocking function | 1(Active) | 3 (P Aux) | 3 (P Aux) |
| I1 | Function I1 | 1 (Float) | | |
| I2 | Function I2 | 3 (P Aux) | | |
| I3 | Function I3 | 5 (Disable) | | |
| I4 | Function I4 | 10 (Low press) | | |
| O1 | Output 1 function | 2 | 2 | 2 |
| O2 | Output 2 function | 2 | 2 | 2 |

AD T/T 3.0 AC – AD T/T 4.0 AC – AD T/T 5.5 AC

| MENUS AND DEFAULT VALUES | | | | |
|--|---|--------------------|------------|------------|
| DESCRIPTION | | Factory parameters | | |
| Indications on the display in normal operation | | A. T/T 3.0 | A. T/T 4.0 | A. T/T 5.5 |
| LA | Language | ITA | ITA | ITA |
| SP | Setpoint pressure [bar] | 3,0 | 3,0 | 3,0 |
| P1 | Setpoint P1 [bar] | 2,0 | 2,0 | 2,0 |
| P2 | Setpoint P2 [bar] | 2,5 | 2,5 | 2,5 |
| P3 | Setpoint P3 [bar] | 3,5 | 3,5 | 3,5 |
| P4 | Setpoint P4 [bar] | 4,0 | 4,0 | 4,0 |
| FP | Test frequency in manual mode | 40,0 | 40,0 | 40,0 |
| RC | Rated current of electric pump [A] | 0,0 | 0,0 | 0,0 |
| RT | Direction of rotation | 0 (UVW) | 0 (UVW) | 0 (UVW) |
| FN | Rated frequency [Hz] | 50,0 | 50,0 | 50,0 |
| OD | Type of system | 1 (Rigid) | | |
| RP | Restart pressure [bar] | 0,5 | 0,5 | 0,5 |
| AD | Address | 0 (Auto) | | |
| PR | Pressure sensor | 1 (501 R 25 bar) | | |
| MS | Measurement system | 0 (International) | | |
| FI | Flow sensor | 1 (Flow X3 F3.00) | | |
| FD | Pipeline diameter [inch] | 2 | 2 | 2 |
| FK | K-factor [pulse/l] | 24,40 | 24,40 | 24,40 |
| FZ | Minimum shutdown flow [l/min] | 0 | 0 | 0 |
| FT | Delay for water failure block [s] | 5 | 5 | 5 |
| SO | Dry running factor | 22 | 22 | 22 |
| MP | Minimum pressure pump stop [bar] | 0,0 | 0,0 | 0,0 |
| TB | Shutdown delay [s] | 10 | 10 | 10 |
| T1 | Shutdown time after low pressure signal | 2 | 2 | 2 |
| T2 | Shutdown delay [s] | 10 | 10 | 10 |
| GP | Proportional gain coefficient | 0,6 | 0,6 | 0,6 |
| GI | Integral gain coefficient | 1,2 | 1,2 | 1,2 |
| FS | Maximum rotation frequency [Hz] | 50,0 | 50,0 | 50,0 |
| FL | Minimum rotation frequency [Hz] | 0,0 | 0,0 | 0,0 |
| NA | Active inverters | N | N | N |
| NC | Simultaneous inverters | NA | NA | NA |
| IC | Reserve configuration | 1 (Auto) | 1 (Auto) | 1 (Auto) |
| ET | Exchange time [h] | 2 | 2 | 2 |
| CF | Carrier [kHz] | 5 | | |
| AC | Acceleration | 3 | | |
| AE | Anti-blocking function | 1 (Active) | 1 (Active) | 1 (Active) |
| I1 | Function I1 | 1 (Float) | | |
| I2 | Function I2 | 3 (P Aux) | | |
| I3 | Function I3 | 5 (Disable) | | |
| I4 | Function I4 | 10 (Low press) | | |
| O1 | Output 1 function | 2 | 2 | 2 |
| O2 | Output 2 function | 2 | 2 | 2 |

AD T/T 7.5 AC – AD T/T 11.0 AC – AD T/T 15.0 AC

| MENUS AND DEFAULT VALUES | | | | |
|--|---|--------------------|------------|------------|
| DESCRIPTION | | Factory parameters | | |
| Indications on the display in normal operation | | A. T/T 7.5 | A. T/T 11 | A. T/T 15 |
| LA | Language | ITA | ITA | ITA |
| SP | Setpoint pressure [bar] | 3,0 | 3,0 | 3,0 |
| P1 | Setpoint P1 [bar] | 2,0 | 2,0 | 2,0 |
| P2 | Setpoint P2 [bar] | 2,5 | 2,5 | 2,5 |
| P3 | Setpoint P3 [bar] | 3,5 | 3,5 | 3,5 |
| P4 | Setpoint P4 [bar] | 4,0 | 4,0 | 4,0 |
| FP | Test frequency in manual mode | 40,0 | 40,0 | 40,0 |
| RC | Rated current of electric pump [A] | 0,0 | 0,0 | 0,0 |
| RT | Direction of rotation | 0 (UVW) | 0 (UVW) | 0 (UVW) |
| FN | Rated frequency [Hz] | 50,0 | 50,0 | 50,0 |
| OD | Type of system | 1 (Rigid) | | |
| RP | Restart pressure [bar] | 0,5 | 0,5 | 0,5 |
| AD | Address | 0 (Auto) | | |
| PR | Pressure sensor | 1 (501 R 25 bar) | | |
| MS | Measurement system | 0 (International) | | |
| FI | Flow sensor | 1 (Flow X3 F3.00) | | |
| FD | Pipeline diameter [inch] | 2 | 2 | 2 |
| FK | K-factor [pulse/l] | 24,40 | 24,40 | 24,40 |
| FZ | Minimum shutdown flow [l/min] | 0 | 0 | 0 |
| FT | Delay for water failure block [s] | 5 | 5 | 5 |
| SO | Dry running factor | 22 | 10 | 10 |
| MP | Minimum pressure pump stop [bar] | 0,0 | 2 | 2 |
| TB | Shutdown delay [s] | 10 | 10 | 10 |
| T1 | Shutdown time after low pressure signal | 2 | 0,6 | 0,6 |
| T2 | Shutdown delay [s] | 10 | 1,2 | 1,2 |
| GP | Proportional gain coefficient | 0,6 | 50,0 | 50,0 |
| GI | Integral gain coefficient | 1,2 | 0,0 | 0,0 |
| FS | Maximum rotation frequency [Hz] | 50,0 | N | N |
| FL | Minimum rotation frequency [Hz] | 0,0 | NA | NA |
| NA | Active inverters | N | 1 (Auto) | 1 (Auto) |
| NC | Simultaneous inverters | NA | 2 | 2 |
| IC | Reserve configuration | 1 (Auto) | 5 | 5 |
| ET | Exchange time [h] | 2 | 3 | 3 |
| CF | Carrier [kHz] | 5 | | |
| AC | Acceleration | 3 | | |
| AE | Anti-blocking function | 1 (Active) | 1 (Active) | 1 (Active) |
| I1 | Function I1 | 1 (Float) | | |
| I2 | Function I2 | 3 (P Aux) | | |
| I3 | Function I3 | 5 (Disable) | 2 | 2 |
| I4 | Function I4 | 10 (L.p.) | 2 | 2 |
| O1 | Output 1 function | 2 | 2 | 2 |
| O2 | Output 2 function | 2 | 2 | 2 |





Via Marco Polo, 14 - Mestrino (PD) Italy - Phone +39.049.5125000 - Fax +39.049.5125950
Customer Service: Tel.: +39.049.5125350 - Fax +39.049.5125959 - email: customer.service@dwtgroup.com
www.dabpumps.com

**DAB PUMPS LTD.**

Unit 4, Stortford Hall Industrial
Park Dunmow Road, Bishops Stortford, Herts
CM23 5GZ - UK
info.uk&eire@dwtgroup.com
Tel.: +44 1279 652 776
Fax: +44 1279 657 727

**DAB PUMPS B.V.**

Albert Einsteinweg, 4
5151 DL Drunen - Nederland
info.netherlands@dwtgroup.com
Tel.: +31 416 387280
Fax: +31 416 387299

**DAB PUMPS B.V.**

Brusselstraat 150
B-1702 Groot-Bijgaarden - Belgium
info.belgium@dwtgroup.com
Tel.: +32 2 4668353
Fax: +32 2 4669218

**DAB PUMPEN DEUTSCHLAND GmbH**

Tackweg 11
D - 47918 Tönisvorst - Germany
info.germany@dwtgroup.com
Tel.: +49 2151 82136-0
Fax: +49 2151 82136-36

**PUMPS AMERICA, INC. DAB PUMPS DIVISION**

3226 Benchmark Drive
Ladson, SC 29456 USA
info.usa@dwtgroup.com
Ph. : 1-843-824-6332
Toll Free : 1-866-896-4DAB (4322)
Fax : 1-843-797-3366

**DAB PUMPS IBERICA S.L.**

Parque Empresarial San Fernando
Edificio Italia Planta 1ª
28830 - San Fernando De Henares - Madrid
Spain
info.spain@dwtgroup.com
Ph.: +34 91 6569545
Fax: +34 91 6569676

**OOO DWT GROUP**

100 bldg. 3 Dmitrovskoe highway,
127247 Moscow - Russia
info.russia@dwtgroup.com
Tel.: +7 495 739 52 50
Fax: +7 495 485-3618

**DAB PUMPS CHINA**

No.40 Kaituo Road, Qingdao Economic & Technological
Development Zone
Qingdao City, Shandong Province, China
PC: 266500
info.china@dwtgroup.com
Fax +8653286812210
Tel. +8653286812030-6270